

The Super and Duper Starter Book

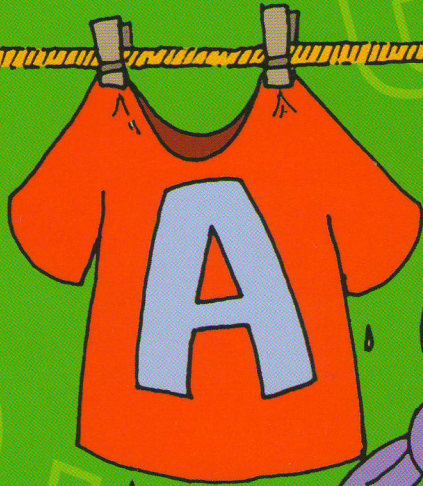
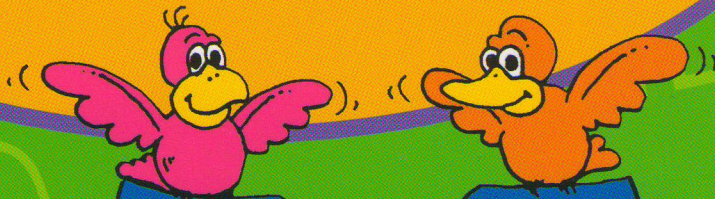
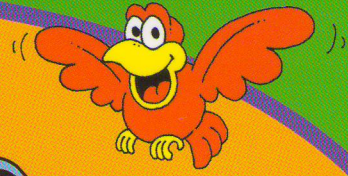

 **NEW EDITIONS**
English Language Teaching

THOMSON

HEINLE



Hello! What's your name?

Hello. My name's Mr Marvel.
I'm your teacher.
What's your name?

Hi! I'm Super.
What's your name?

Hi! My name's Duper.

Hi! I'm Cindy.

Hello!
My name's Zack.

My name's Peter.
What's your name?



My name's Super.....

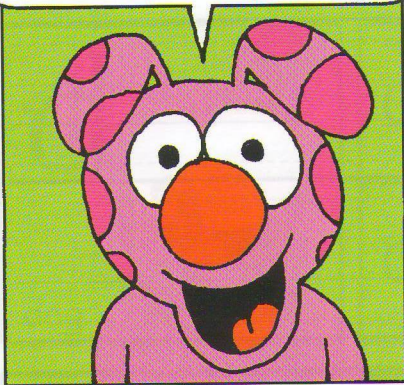

My name's Duper.....



I'm Mr Marvel..

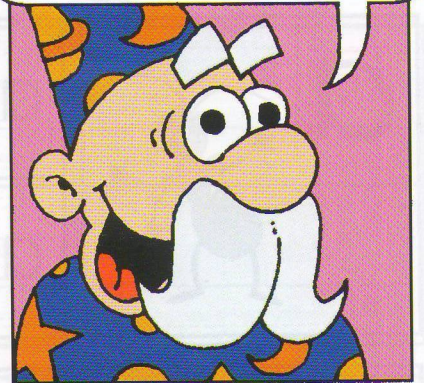

My name's Cindy.....

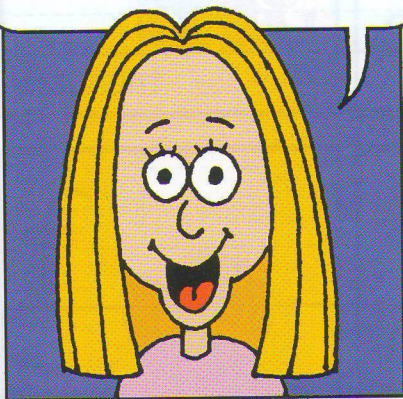

I'm Peter.....



I'm Zack.....
What's your name?

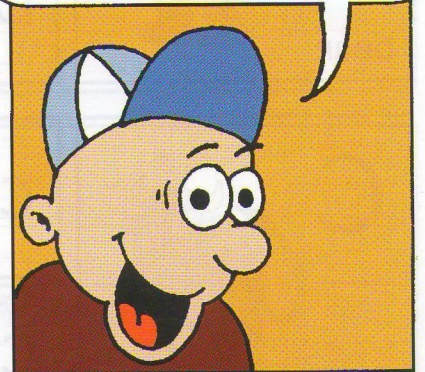

Hello, my name is Super.

Hello, my name is Duper.

Hello, I'm Mr Marvel.

Hello! Hello! Hello!

Hello, I am Cindy.

Hello, I am Peter.

Hello, my name is Zack.

Surprise! Surprise! Surprise!



Unit 1

Aa Bb Cc Dd Ee Ff Gg Hh Ii Jj Kk Ll



a

ant

a aa

a

b

bear

b bb

b

c

cow

c cc

c

A Find and circle.

a b@cacbcacbacbca
b acbbcbabaacbcba
c cabacbaacbcacbc

B Write and find the stickers.

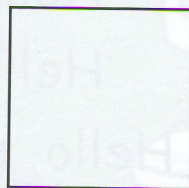
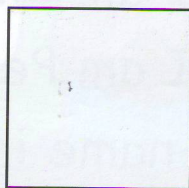
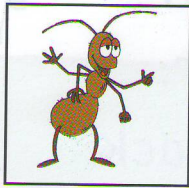

ant

_ow

_ear



Mm Nn Oo Pp Qq Rr Ss Tt Uu Vv Ww Xx Yy Zz

d

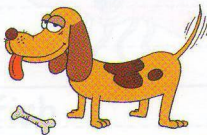

dog

d dd

d

e

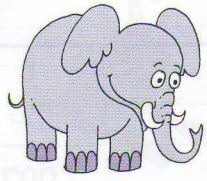

elephant

e ee

e

f



frog

f ff

f

C Write.

ant _rog _lephant

_ear _og _ow

D Write and find the stickers.

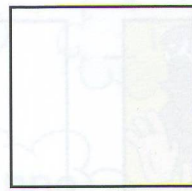
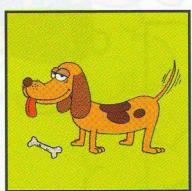

dog _rog _lephant



g

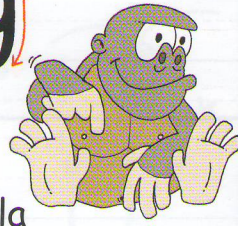

gorilla

g g g

g

h

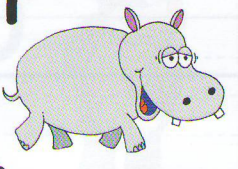

hippo

h h h

h

i

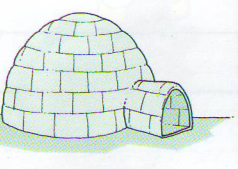

igloo

i i i

i

E Find and circle.

g @ahbiagdgbgcdcga
h fhbdihjbadhidgh
i ihaidbihdgi hchf

F Write and find the stickers.

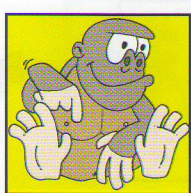
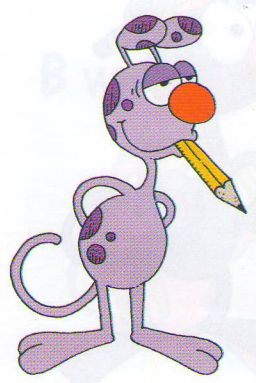

g orilla

_ gloo

_ ippo



Mm Nn Oo Pp Qq Rr Ss Tt Uu Vv Ww Xx Yy Zz

j 
jellyfish

j j j
j

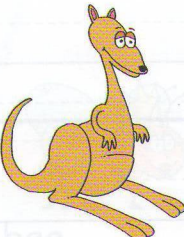
k 
kangaroo

k k k
k

l 
lion

l l l
l

G Write.

a _ c _ e f
_ h i _ k l

H Write.

k angaroo _ ellyfish _ ion
_ gloo _ orilla _ ippo



m m m

monkey

m m m

m

n n n

nose

n n n

n

o o o

octopus

o o o

o

Find and circle.



m h m n h m n h n e g a m c n m

n n m h a n k b h m n h b a n m

o c a o g c o g a c o b e c o a

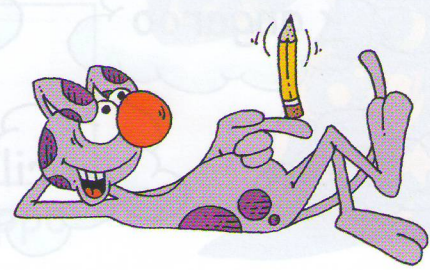

Mm Nn Oo Pp Qq Rr Ss Tt Uu Vv Ww Xx Yy Zz

p

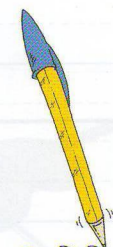

pen

ppp

p

q

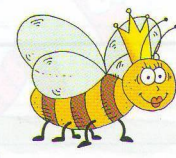

queen bee

qqq

q

r



rabbit

rrr

r

J Find and circle.

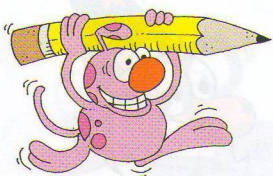

p p q q o q p g p b p d r p g p
 q g o q p p g d o q p q b d q o g
 r p r h r h r k s m r q s n r k



K Write and find the stickers.

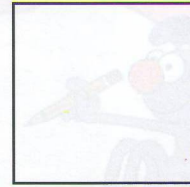
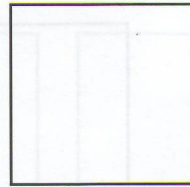
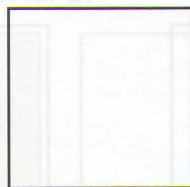
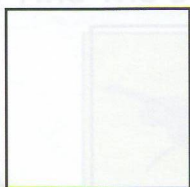
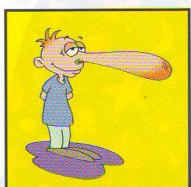

nose

_en

_ctopus

_onkey

_ueen bee

_abbit

Unit
1

Aa Bb Cc Dd Ee Ff Gg Hh Ii Jj Kk Ll

S

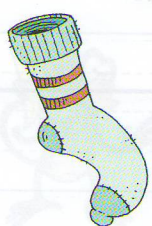

sock

SSS

S

t



tiger

ttt

t

u



umbrella bird

uuu

u

L Find and circle.

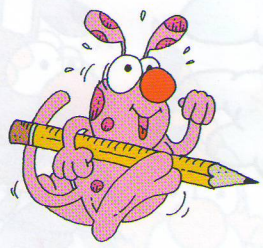

S s n o r c s r c m e s c a s a
 t k i f t k l t i t f t f h t k
 u n u a o u q c h c u o n r u n



M Write and find the stickers.

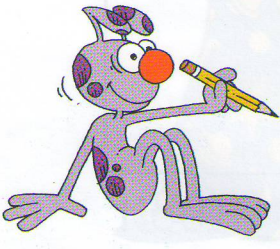

sock _ mbrella bird _ iger



V

violin

V V V

V

W

worm

W W W

W

X

fox

X X X

X

N Find and circle.



O Write and find the stickers.

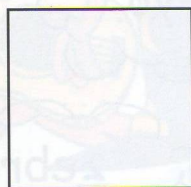
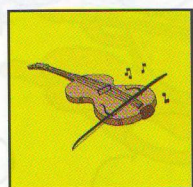

v iolin

fo_

_orm

Unit 1

Aa Bb Cc Dd Ee Ff Gg Hh Ii Jj Kk Ll

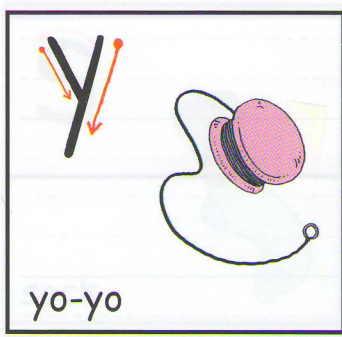

yo-yo

y yy

y

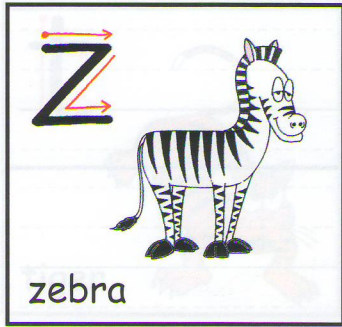

zebra

z zzz

z

P Find and circle.

y v j q y v x y u w y z q j y

z x s c z e z s z z y z s y c z

Q Write and find the stickers.

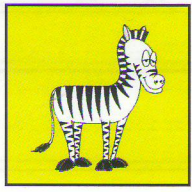

zebra

_o-yo

R Write.



_iger

fo_

_orm

_o-yo

_iolin

zebra

_ock

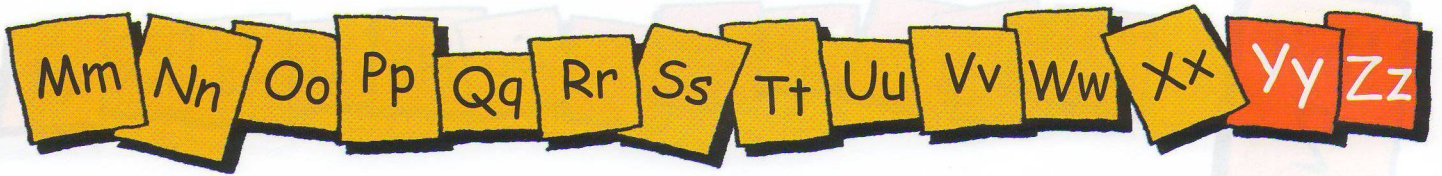

S Write.

<u>a</u>	b	c	—	e	f
g	—	i	—	k	l
m	—	o	—	q	—
s	t	—	v	—	x
—	z				

T Sing the Alphabet Song! 



Unit 2

Aa Bb Cc Dd Ee Ff Gg Hh Ii Jj Kk Ll



A

yo-yo
APPLE

A A A

A

B

zebra
BANANA

B B B

B

C

CAKE

C C C

C

A Find and circle.



A B A F A B A C A B B A C C B A
 B A C B A B B C B A A C B A B C
 C C A C B C A B A C B C A C B C

B Write and find the stickers.

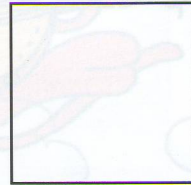
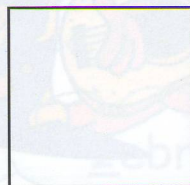

CAKE

_ANANA

_PPLE



Mm Nn Oo Pp Qq Rr Ss Tt Uu Vv Ww Xx Yy Zz

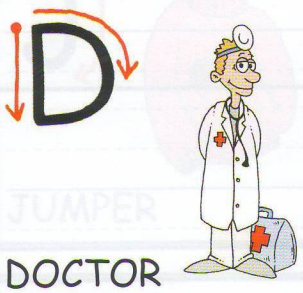

DOCTOR

DDD

D

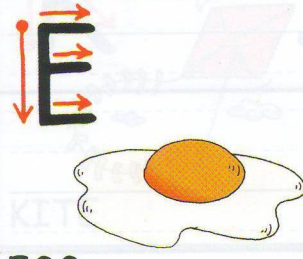

EGG

EEE

E

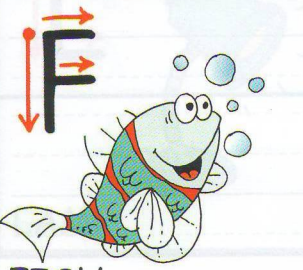

FISH

FFF

F

C Find and circle.

D F B **D** C D A B C D F B D E D A
 E A E F D E B F E A C E F E C F
 F D F E C A E C F D E A B F B F

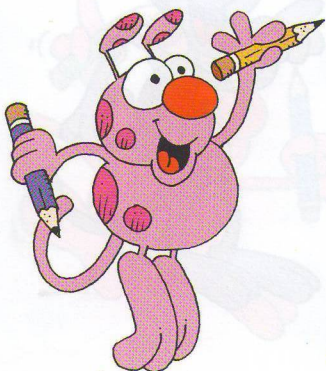

D Write and find the stickers.

--	--	--

 DOCTOR

 ISH

 GG





GRAPES

G G G

G

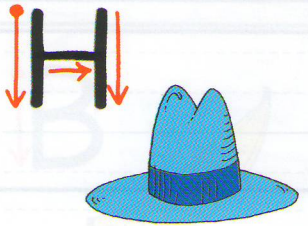

HAT

H H H

H



IGUANA

I I I

I

E Find and circle.



G A G H B G B G H I B G C D G C
 H F C H E F H I B A D H I G E B
 I I H A I G B I H D F I E C I I

F Write and find the stickers.

GRAPES _GUANA _AT



Mm Nn Oo Pp Qq Rr Ss Tt Uu Vv Ww Xx Yy Zz

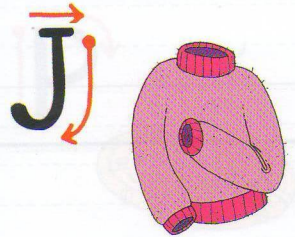

JUMPER

J J J

J



KITE

K K K

K

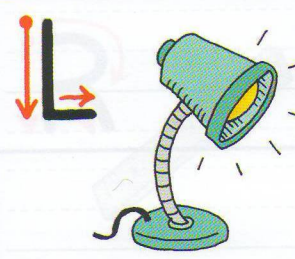

LAMP

L L L

L

6 Find and circle.

J L J B E J I H F G K J I L H I
 K K L B D K L J K I C A G D F K
 L F I L J I H B D L K J H L I L

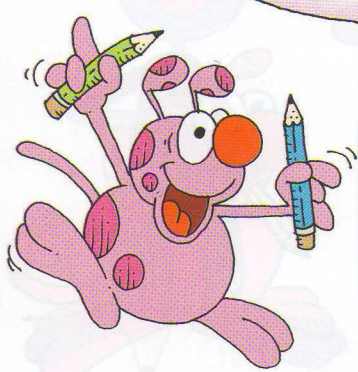

8 Write and find the stickers.

KITE _UMPER _AMP



Unit
2

Aa Bb Cc Dd Ee Ff Gg Hh Ii Jj Kk Ll



MILK

M M M

M

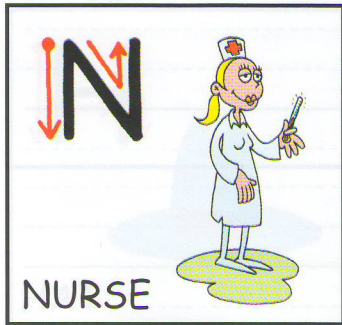

NURSE

N N N

N

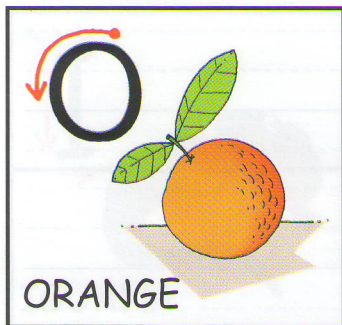

ORANGE

O O O

O

Find and circle.



M M H N O M N I B D A A M C N M
 N N M B A K N L I M N H L A C M
 O C G O D C O G B C O E C D C O

Write and find the stickers.

MILK

_RANGE

_URSE

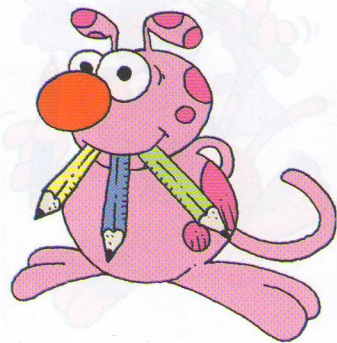

Mm Nn Oo Pp Qq Rr Ss Tt Uu Vv Ww Xx Yy Zz

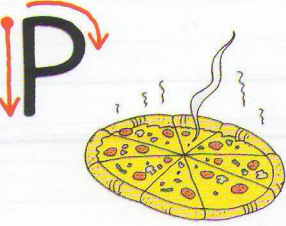

PIZZA

PPP

P



QUEEN

QQQ

Q

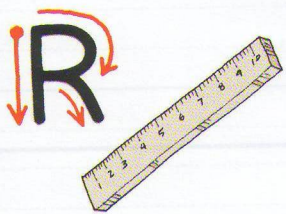

RULER

RRR

R

K Find and circle.

P B P D R F Q O P B P D R P F K
 Q Q O C Q G D C R P G Q B D Q O
 R P R B P B R K F M S Q S N R K

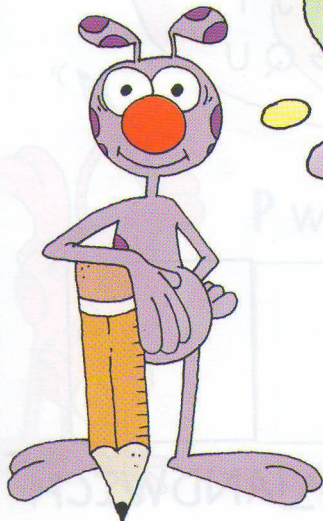

L Write and find the stickers.

--	--	--

QUEEN _ULER _IZZA



S

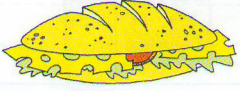

SANDWICH

S S S

S

T

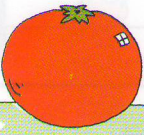

TOMATO

T T T

T

U



UMBRELLA

U U U

U

M Find and circle.

S (S) A O G C S R C B E S K P S A
 T H I J T K L T I T F E F T J T
 U U C D O U P O Q U C U G Q U



N Write and find the stickers.

TOMATO

_MBRELLA

_ANDWICH



UMBRELLA

M Find and circle.

S **Ⓢ** A O G C S R C B E S K P S A
 T H I J T K L T I T F E F T J T
 U U C D O U P O Q U C U G Q U



N Write and find the stickers.

--	--	--

TOMATO

_MBRELLA

_ANDWICH

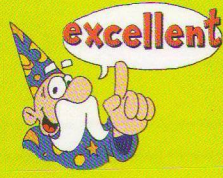
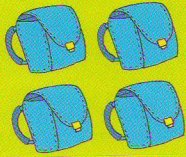
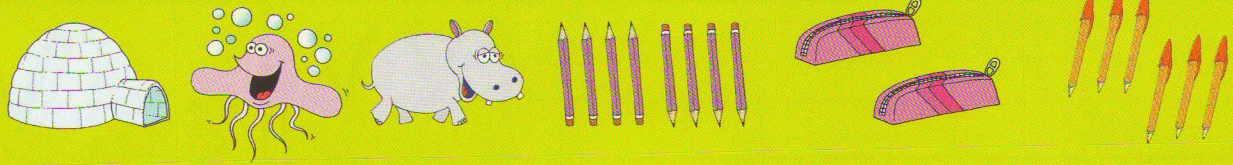
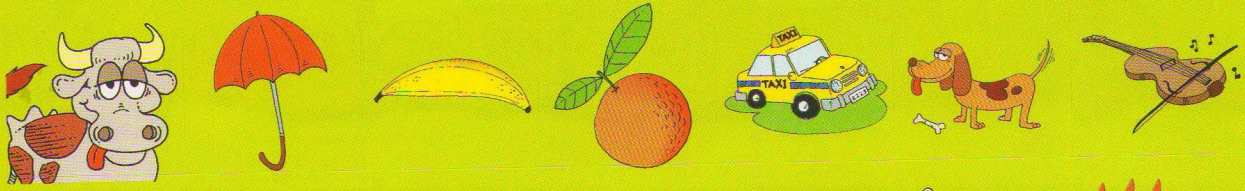

Surprise!

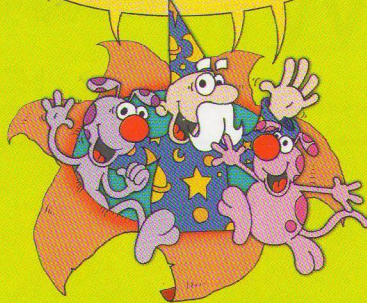

Surprise!

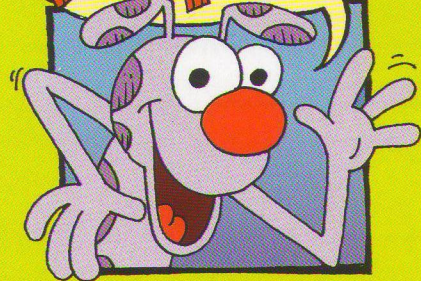

TAXI

0 Find and circle.

V W **U** B W A V U V X W A K V L
 W W U M N V W V E W F V M W V
 X T X F W X J T F K X W K L X H

P Write and find the stickers.



TAXI



_OLLEYBALL



_ATCH

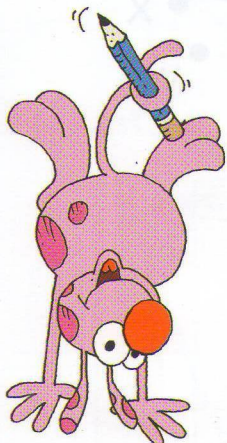

Mm Nn Oo Pp Qq Rr Ss Tt Uu Vv Ww Xx Yy Zz

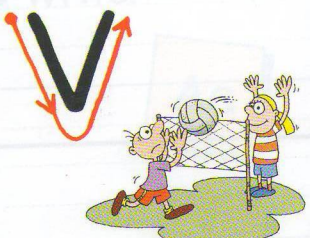

VOLLEYBALL

V V V

V

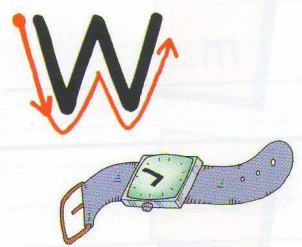

WATCH

W W W

W



TAXI

X X X

X

0 Find and circle.

V W U B W A V U V X W A K V L
 W W U M N V W V E W F V M W V
 X T X F W X J T F K X W K L X H

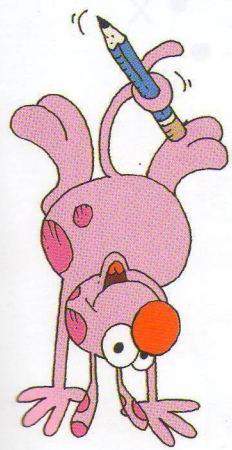

P Write and find the stickers.

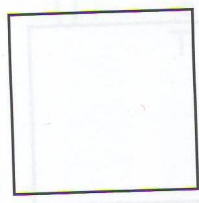

TAXI



_OLLEYBALL



_ATCH



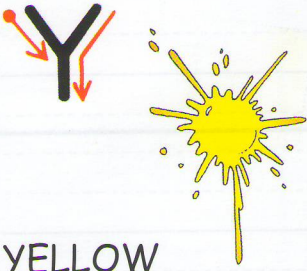

YELLOW

Y Y Y

Y

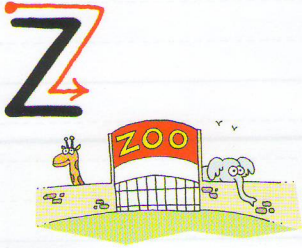

ZOO

Z Z Z

Z

Q Find and circle.

Y UYPRYVKYUWYZIJY
Z SZCHIZCZEYZSFCZ



R Write and find the stickers.



YELLOW

__OO

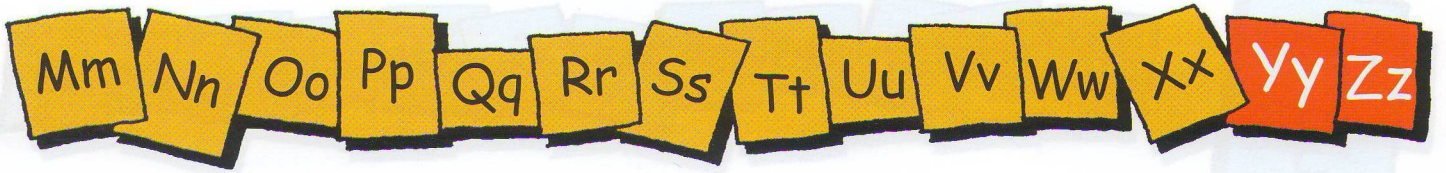

S Write.

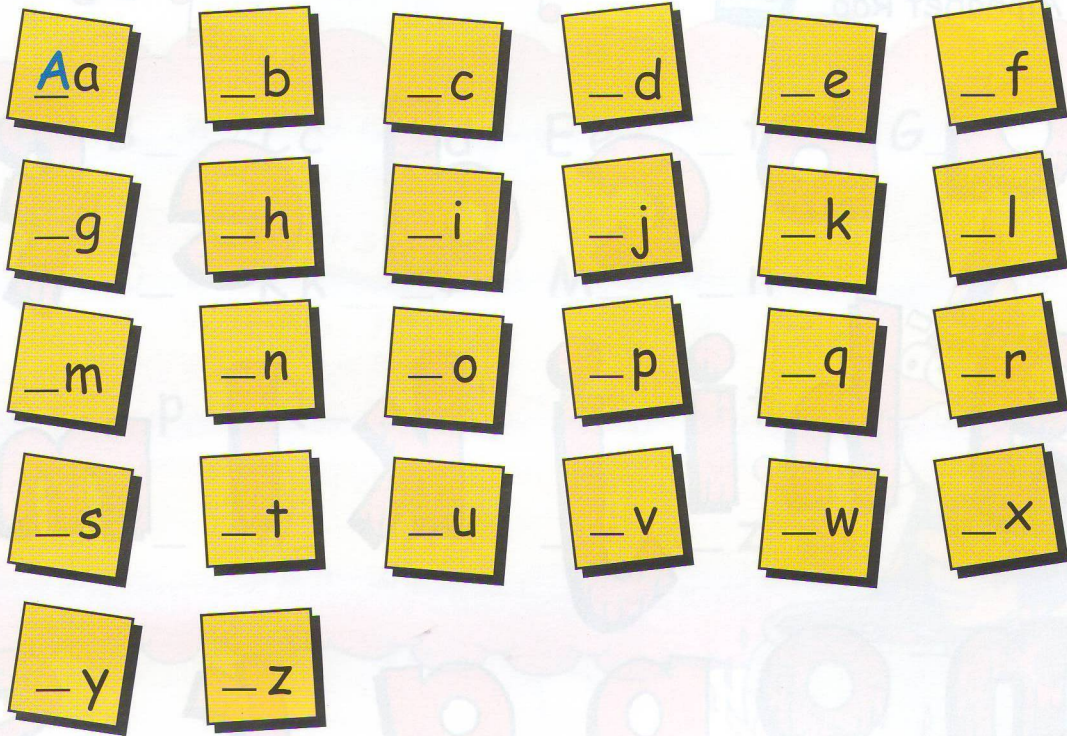

T Draw and colour.

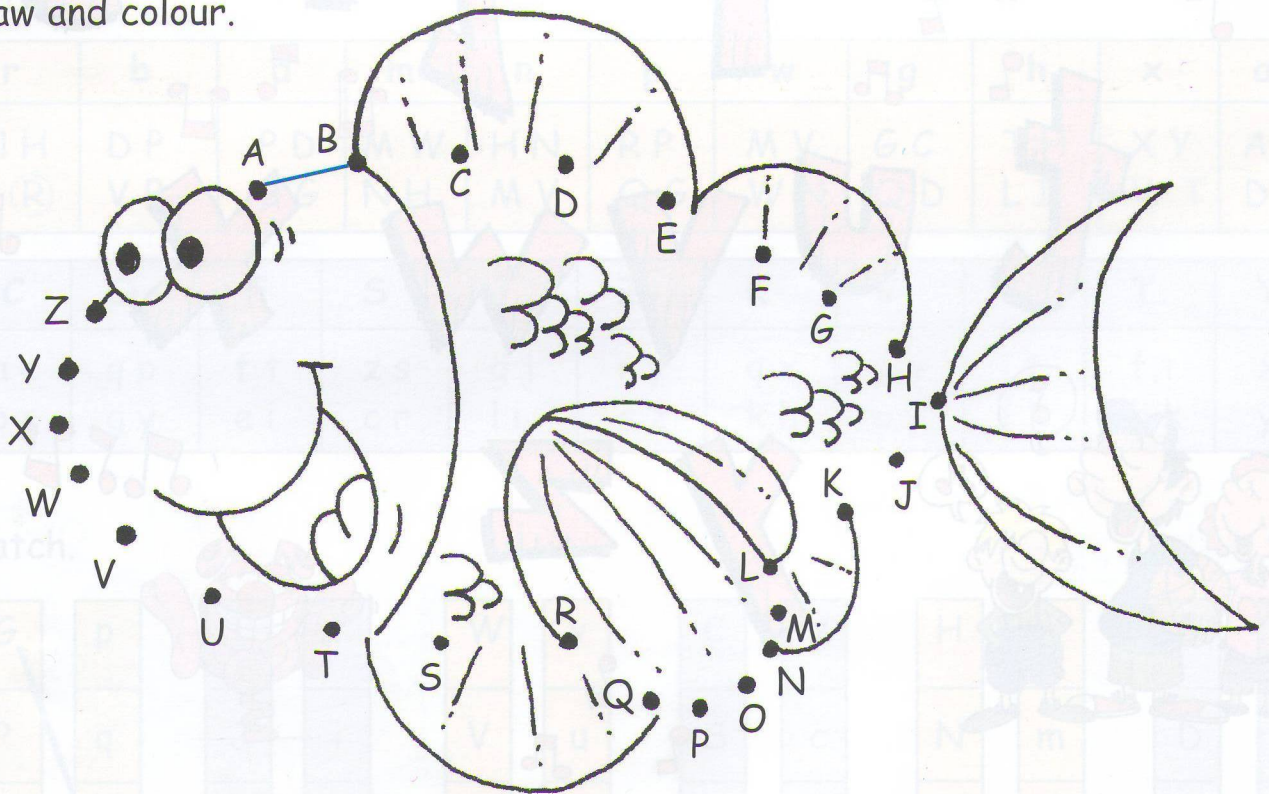

Unit 3

Aa Bb Cc Dd Ee Ff Gg Hh Ii Jj Kk Ll

A Sing the Alphabet Rap. 

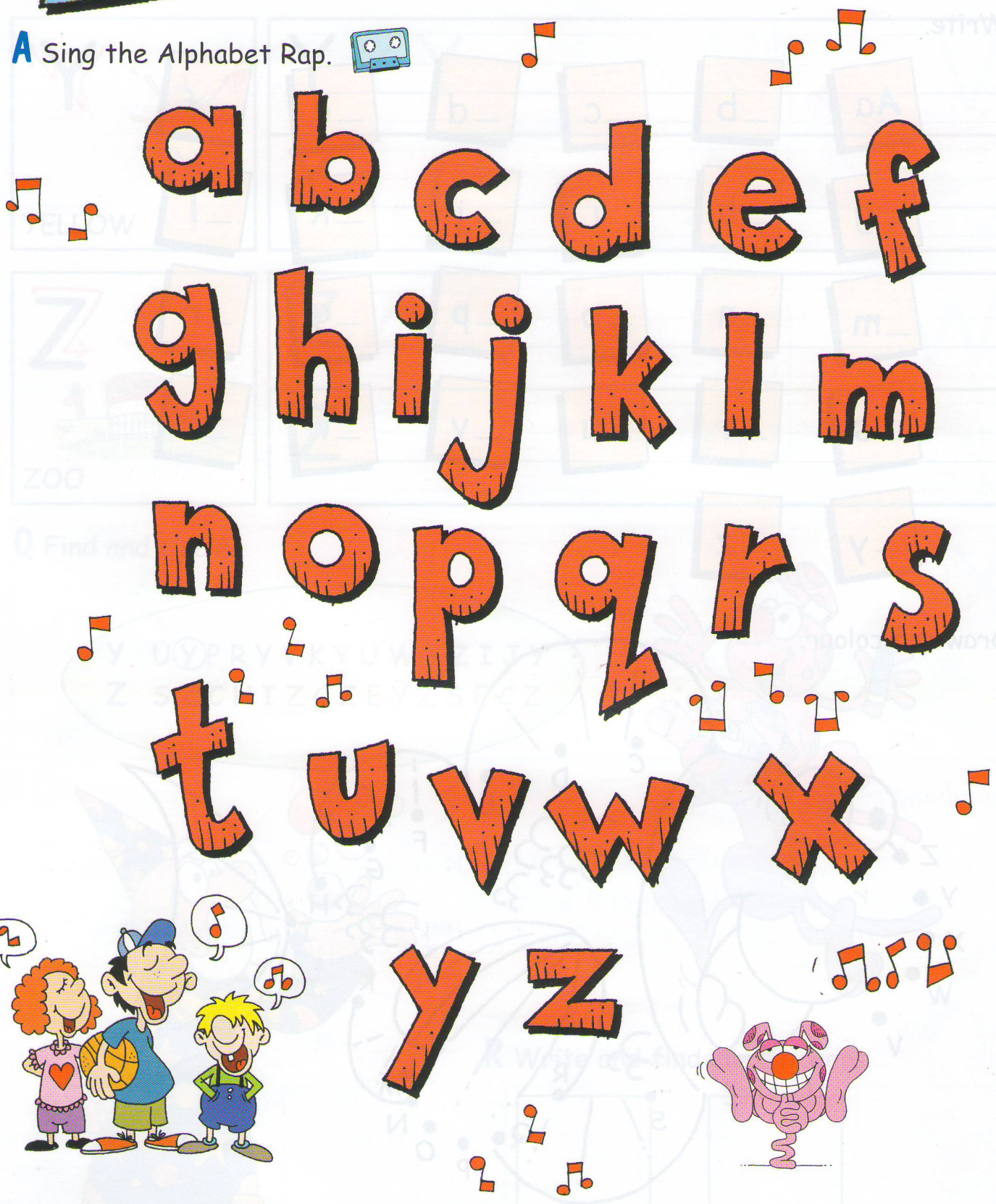

a b c d e f
g h i j k l m
n o p q r s
t u v w x
y z

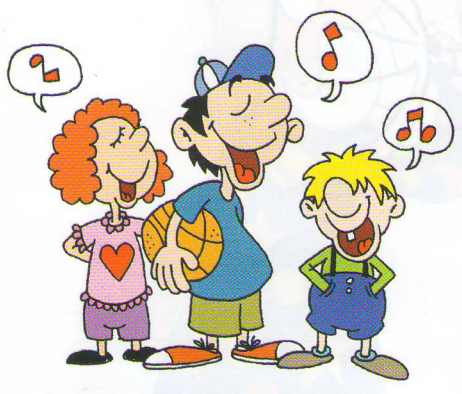

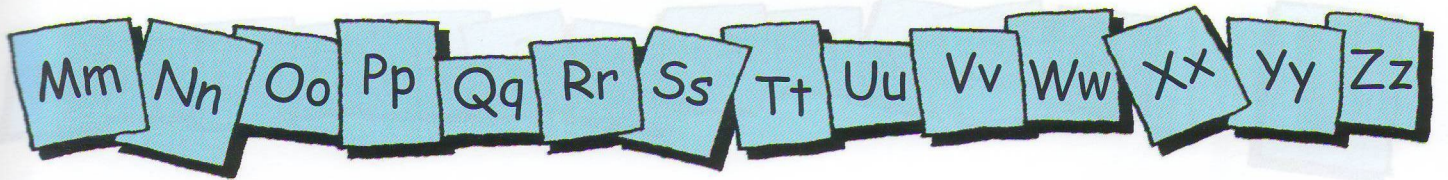

B Write.

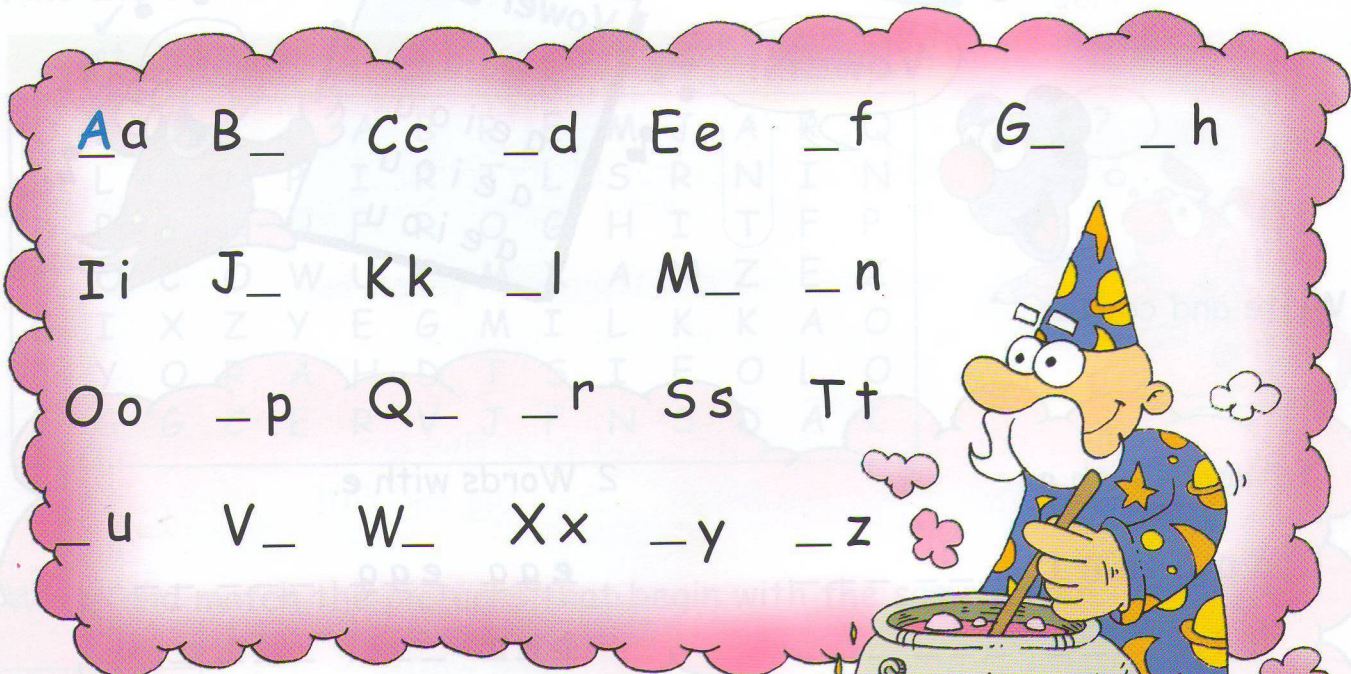

C Circle.

r	b	d	m	n	p	w	g	h	x	a
NH	DP	PD	MW	HN	RP	MV	GC	TH	XY	AS
P (R)	VB	BG	NH	MV	QG	WN	QD	LI	WT	DV

C	Q	F	S	J	Z	K	V	L	T	Y
ac	qp	ft	zs	gj	ry	qx	wv	it	ft	xv
os	gy	ei	cr	li	sz	kh	uy	lj	hk	yj

D Match.

G	p	I	l	W	v	C	z	H	n	B	d
P	q	J	i	V	u	S	c	N	m	D	p
Q	g	L	j	U	w	Z	s	M	h	P	b

E Sing the Vowel Song. 



Vowels!

Vowel Song
aeiou
aeiou
aeiou
aeiou



F Write and copy.

1 Words with a.

ant ant
hat

2 Words with e.

egg egg
pen

3 Words with i.

fish fish
milk
taxi

4 Words with o.

dog dog
fox
sock

5 Words with u.

ruler ruler
jumper
umbrella

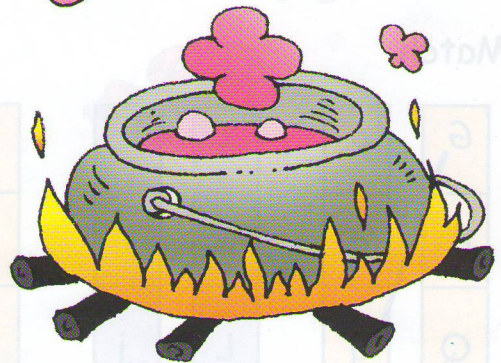

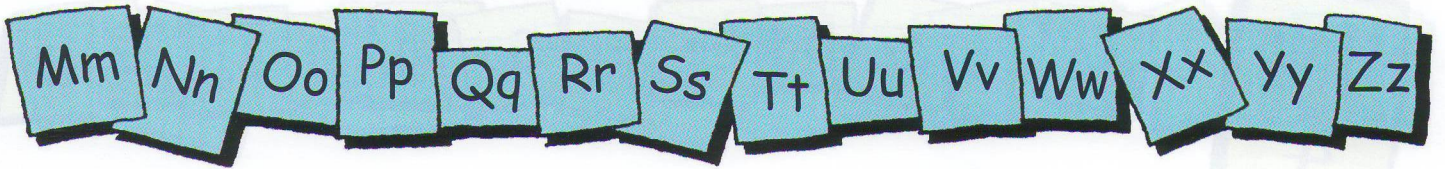

G Find and circle.

ant dog cow egg frog milk zoo lamp

O	Z	U	K	G	A	B	R	E	M	J	A	R	Q
S	L	A	M	P	I	R	T	L	S	R	N	I	N
D	P	I	N	U	F	R	O	G	H	I	T	F	P
O	O	C	O	W	U	E	M	X	A	N	Z	E	Z
G	I	X	Z	Y	E	G	M	I	L	K	K	A	O
T	Y	O	R	A	H	D	T	S	I	E	O	L	O
E	G	G	C	E	R	V	J	F	N	S	D	A	I



H Write and match the pictures that begin with the same letter.

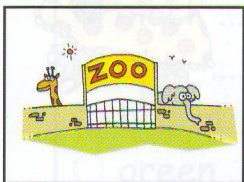

z o o

b _ _ _

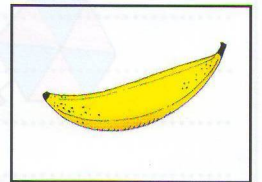

b _ _ _

m _ _ _

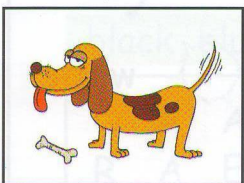
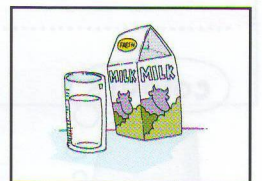

d _ _

z e b r a

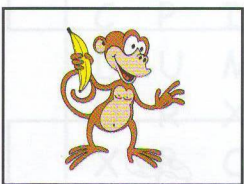

m _ _ _ _

n _ _ _ _

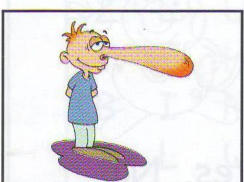

n _ _ _

d _ _ _ _



Unit 4

Aa Bb Cc Dd Ee Ff Gg Hh Ii Jj Kk Ll

Colours

A Sing the Colour Song. 

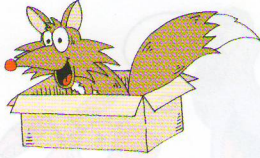

Brown is for the fox in its box.
Yellow is the colour of its socks!

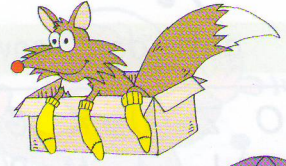

Apples are red and frogs are green.
A purple umbrella for the queen!

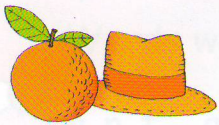
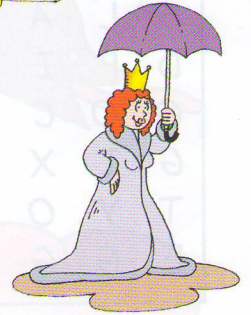

An orange is orange and so is this hat.
Grey is for the hippo — she's big and fat!

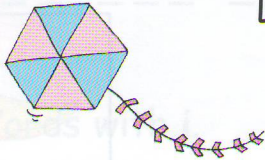







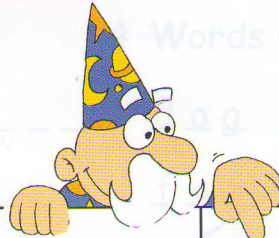



Pink and blue are the colours of my kite.
Look! The zebra is black and white!







Look at the colours!



 red	 pink	 orange	 black
 yellow	 green	 brown	 white
 blue	 purple	 grey	

B Circle Yes or No.

blue?  Yes. No.	brown?  Yes. No.	purple?  Yes. No.	red?  Yes. No.
--	---	---	---

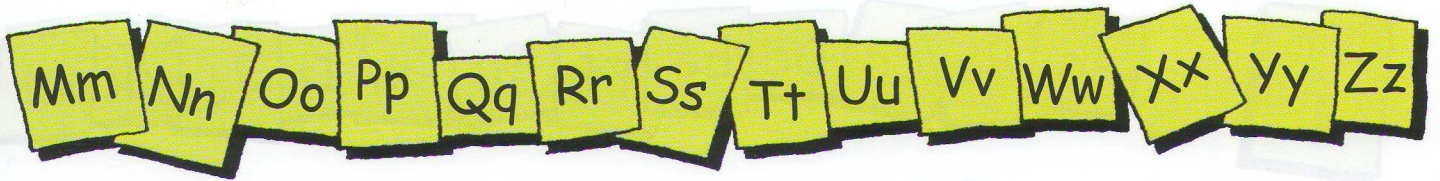

C Match.

purple red yellow brown pink black
blue grey orange white green

D Colour and write in capital letters.

<input checked="" type="radio"/> blackBLACK.....BLACK.....BLACK..... <input type="radio"/> blue <input type="radio"/> brown <input type="radio"/> green <input type="radio"/> grey <input type="radio"/> orange	<input type="radio"/> pink <input type="radio"/> purple <input type="radio"/> red <input type="radio"/> white <input type="radio"/> yellow
--	--

E Find and circle.

black blue brown green grey orange pink purple red white yellow

O	R	A	N	G	E	G	R	E	M	J	A	R	Y	E	L	R	E	D
R	A	E	W	F	I	R	T	G	N	R	S	I	Y	T	V	A	F	A
C	P	I	N	U	A	C	K	W	H	I	T	E	B	R	I	L	E	Q
D	U	M	B	L	U	E	M	X	A	N	Z	E	B	G	J	R	S	Y
U	R	X	Z	R	E	G	N	O	P	Q	H	A	K	R	S	D	O	E
X	P	O	G	R	E	Y	T	S	I	E	O	L	F	E	U	R	D	L
Z	L	U	C	J	N	T	Q	U	N	S	A	Q	I	E	P	V	C	L
W	E	H	<u>B</u>	<u>L</u>	<u>A</u>	<u>C</u>	<u>K</u>	W	K	Q	C	M	B	N	I	L	I	O
B	I	N	K	T	E	W	D	A	C	R	X	J	A	L	V	M	L	W
A	L	U	S	A	Z	B	C	B	R	O	W	N	I	E	R	S	Y	F

Mm Nn Oo Pp Qq Rr Ss Tt Uu Vv Ww Xx Yy Zz

H Write.

purple umbrella blue jumper white taxi

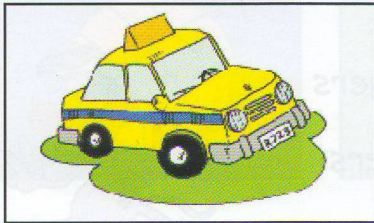
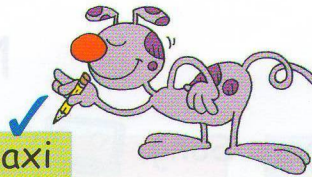

1 yellow taxi.....



2 lamp

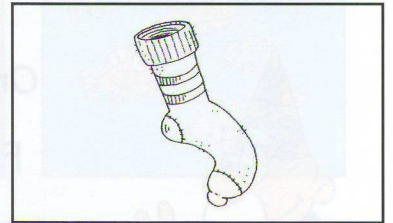

3 sock

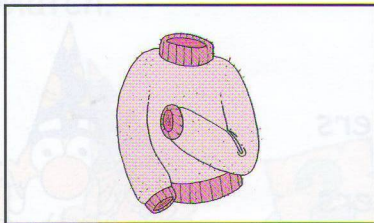

4 pink



5 black

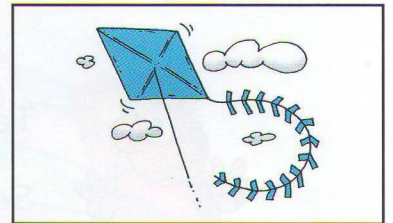

6 kite

I Write the colour and the animal.



1 white dog...

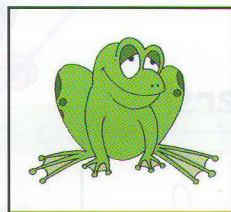

2

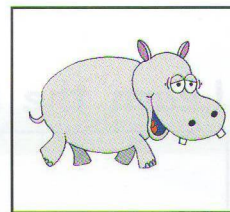

3

Colours

green white grey

Animals

hippo frog dog

J Find and colour.

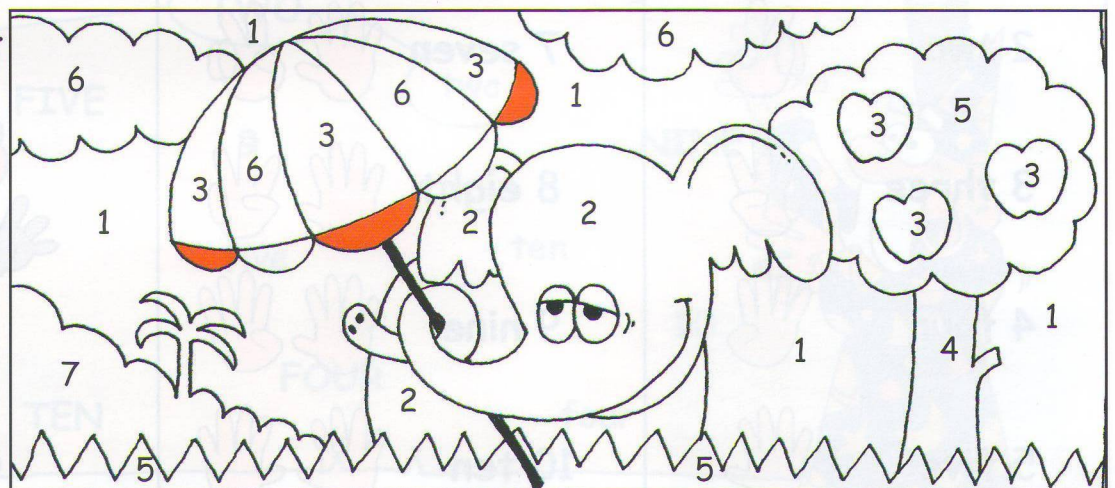

1 blue 2 grey 3 red 4 brown 5 green 6 white 7 black

Unit 5

Aa Bb Cc Dd Ee Ff Gg Hh Ii Jj Kk Ll

Numbers

A Sing the Numbers Song. 



One little, two little, three little fingers
 Four little, five little, six little fingers
 Seven little, eight little, nine little fingers
 Ten fingers on my hands!









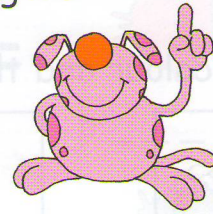







Ten little, nine little, eight little fingers
 Seven little, six little, five little fingers
 Four little, three little, two little fingers



One finger on my hand!



Learn the numbers!

1 one		6 six	 
2 two		7 seven	 
3 three		8 eight	 
4 four		9 nine	 
5 five		10 ten	 

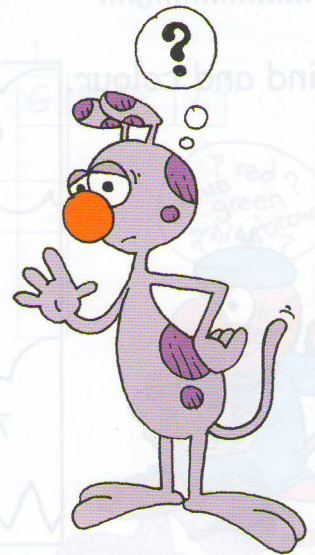

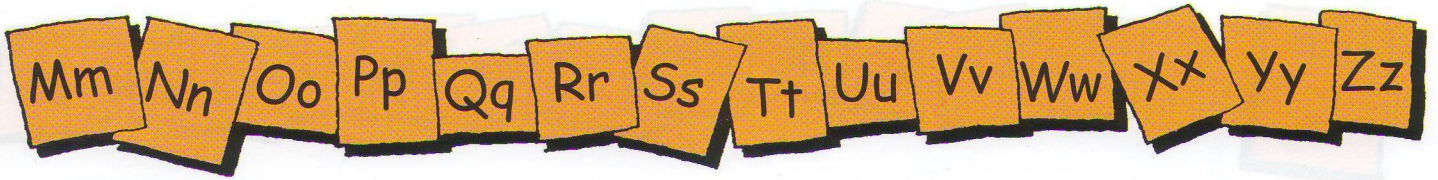

B Write Yes or No.

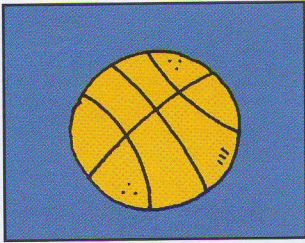

Two? No

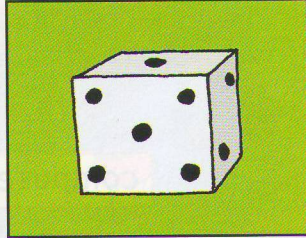

Six?

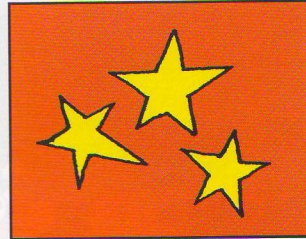

Three?

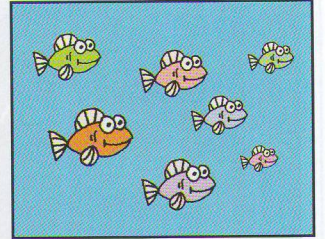

Eight?

C Match.

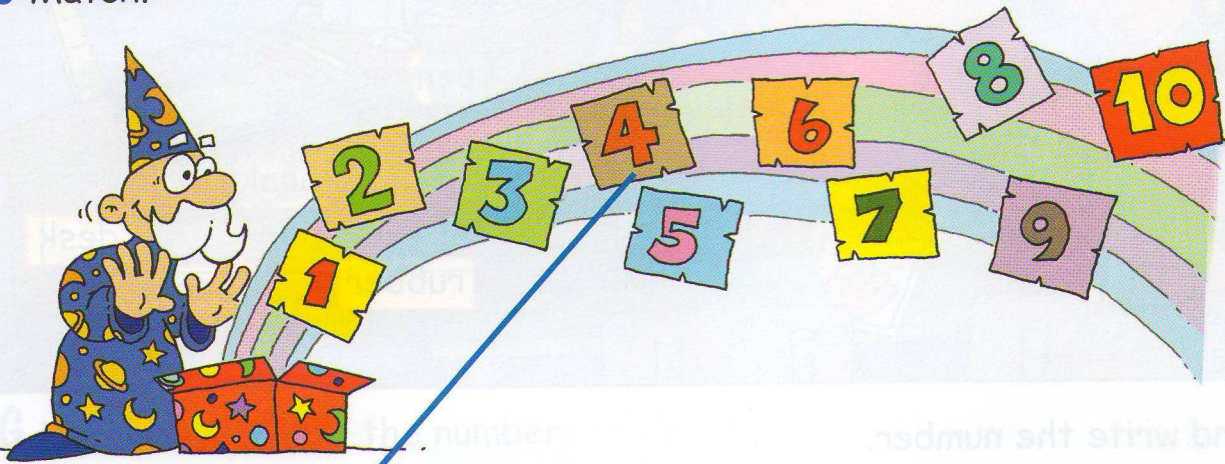

four one nine two six five seven three eight ten

D Connect the numbers.

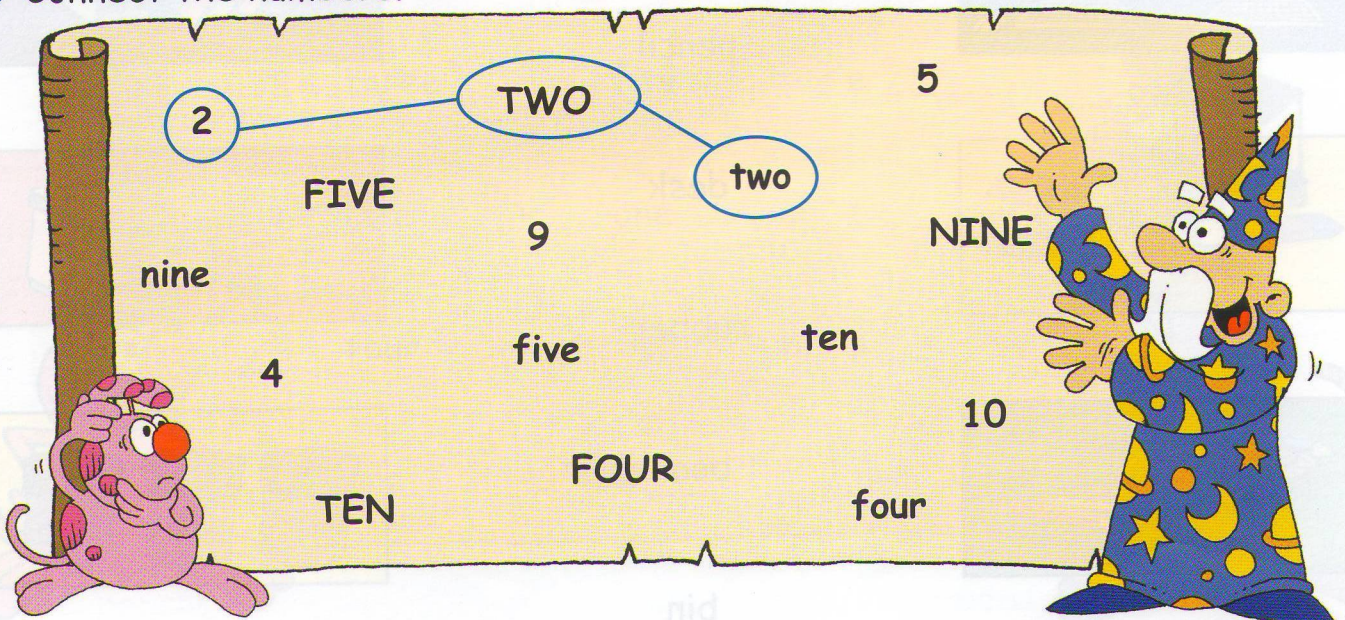

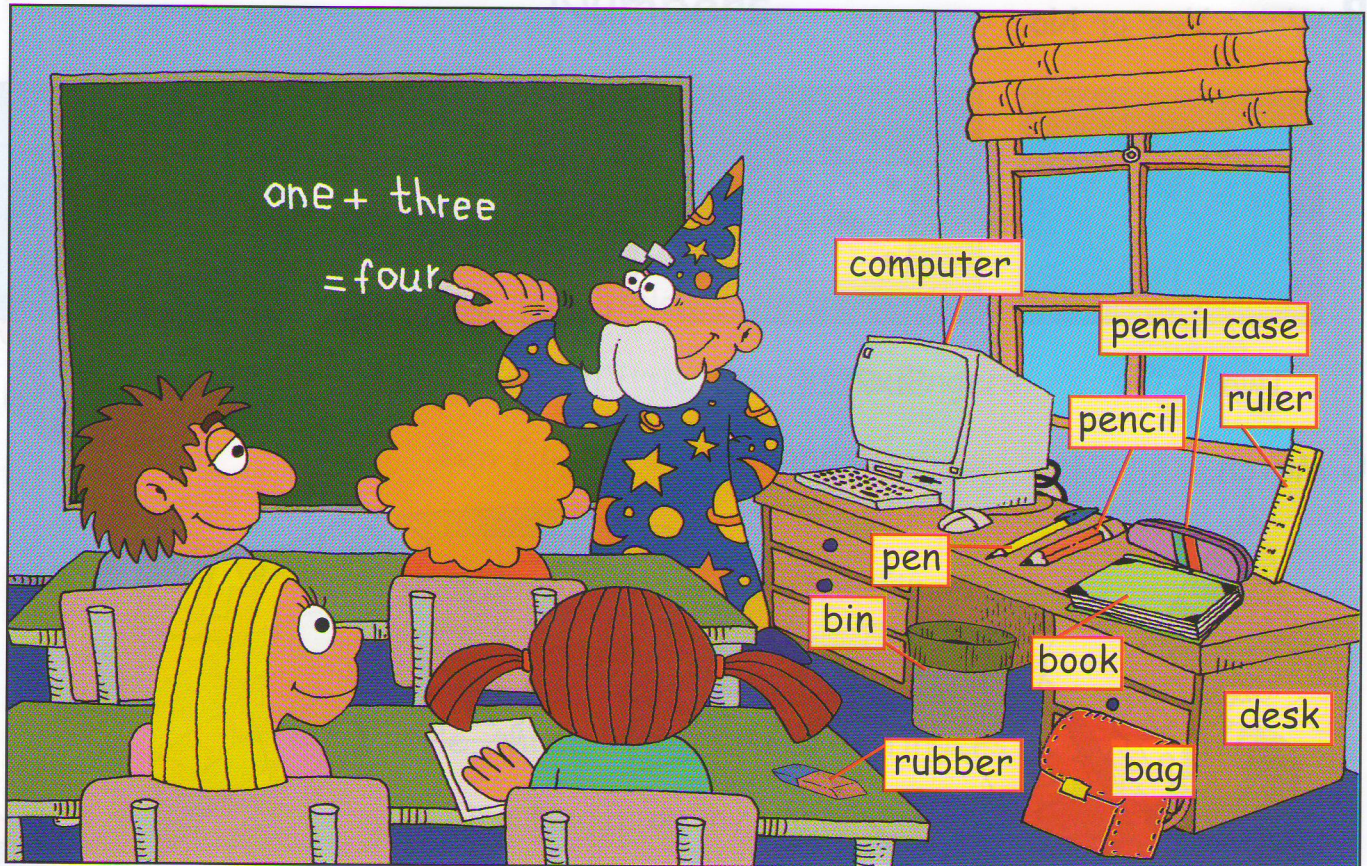

E Match and write the number.

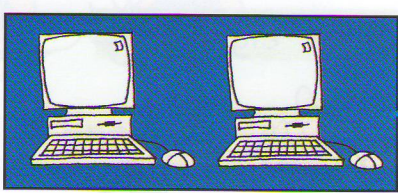

.....two.....

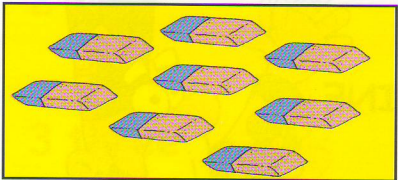

.....

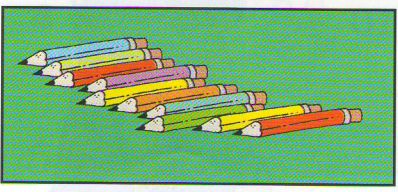

.....

computer

pencil

desk

rubber

book

bin

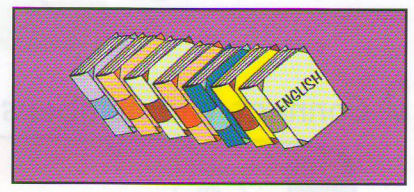

.....

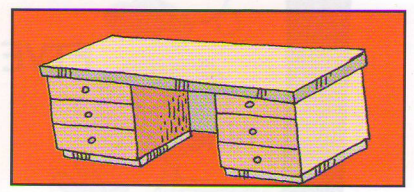

.....

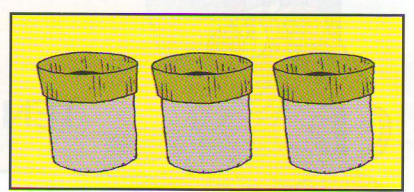

.....

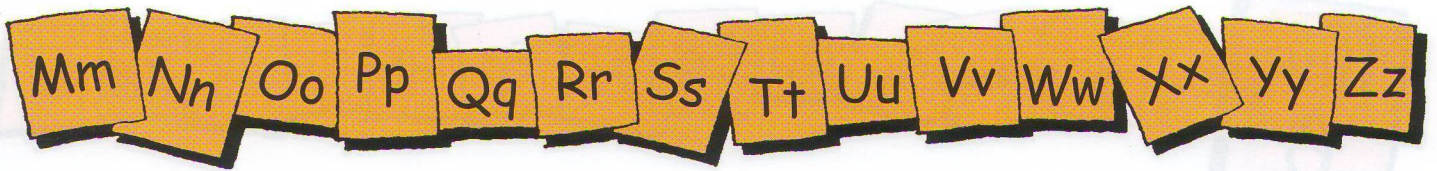

F Write the number.



1 ..four.. boys

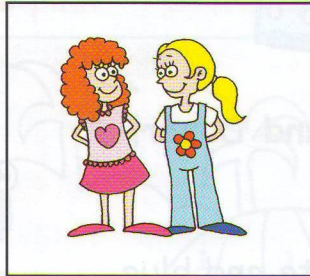

2 girls



3 king

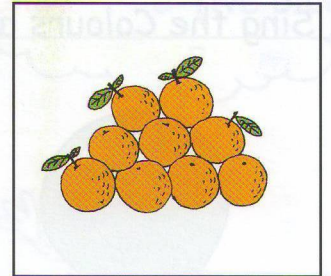

4 oranges

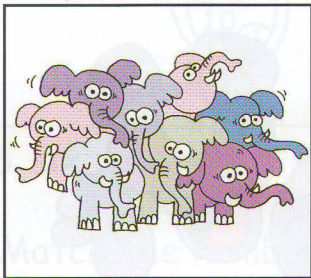

5 elephants



6 bags

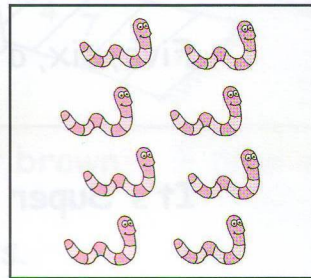

7 worms

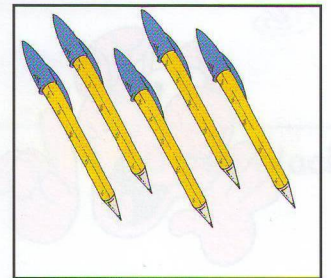

8 pens

G How many? Write the number.

1 one + three = four

2 three + five = e _ _ _

3 nine + one = t _ _

4 four + two = s _ _

5 one + o _ _ = two

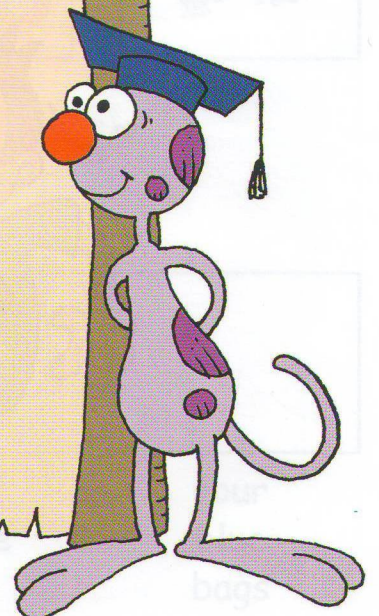

Colours and Numbers

A Sing the Colours and Numbers Song. 

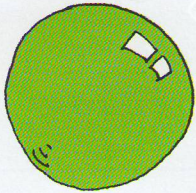

It's Super and Duper!

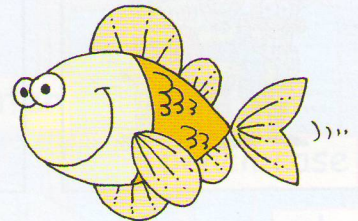

One, two, white and blue.

Three, four, a big green ball.



Five, six, a yellow fish.

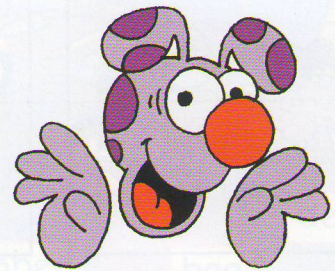

It's Super and Duper!

Seven, eight, a purple cake.

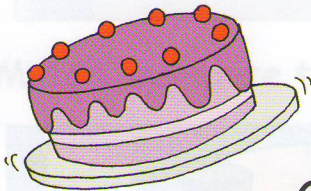

Nine, ten, a big red pen.

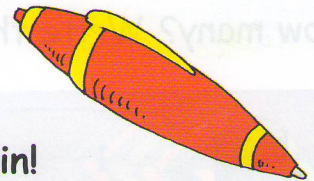

Come on, everybody, let's sing it again!



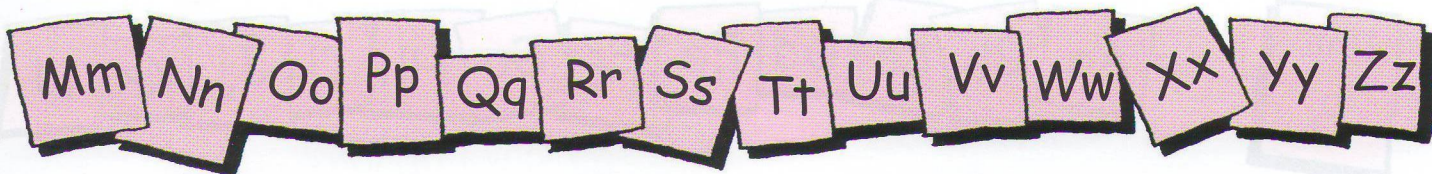

B Find and colour.

- 1 one red 2 two pink 3 three yellow 4 four orange 5 five blue

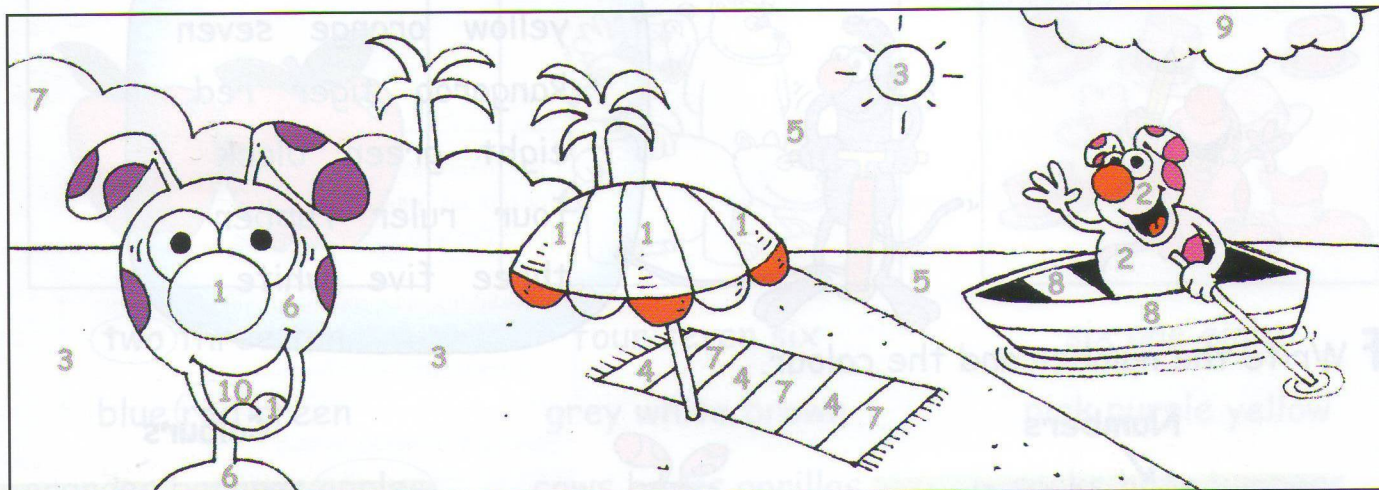

- 6 six purple 7 seven green 8 eight brown 9 nine white 10 ten black

C Match the numbers, colours and animals.

one black dog

three green frogs

nine red ants

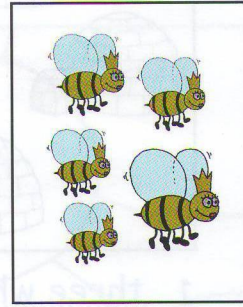
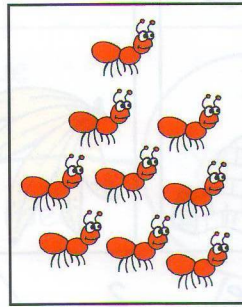
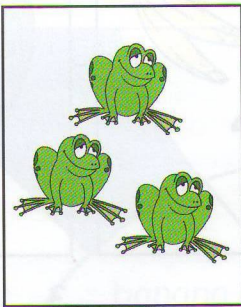
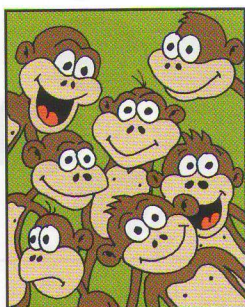

seven brown monkeys

five yellow queen bees

D Find the stickers.

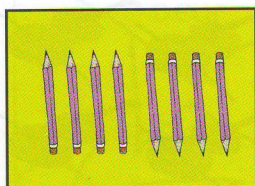

eight
purple
pencils

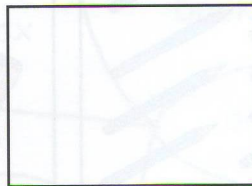
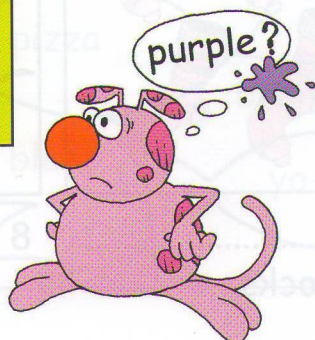

two
pink
pencil cases



six
orange
pens



four
blue
bags

E Cross the odd one out.

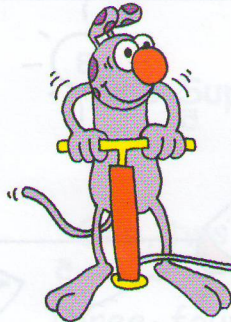

one ~~red~~ two
 yellow orange seven
 kangaroo tiger red
 eight green black
 four ruler rubber
 three five white

F Write the number and the colour.

Numbers

two three four five

six seven nine ten

Colours

brown blue green grey

pink red white yellow

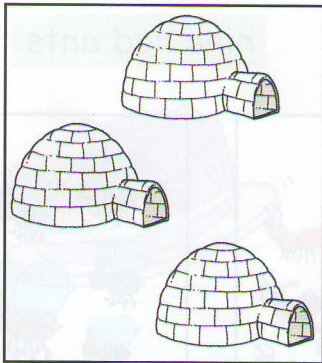

1 three white.....
igloos



2
bananas

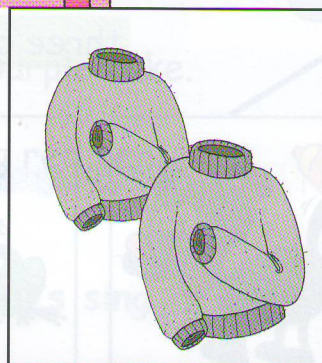

3
jumpers

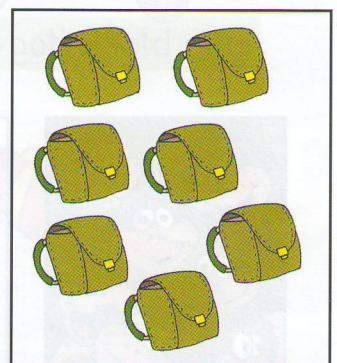

4
bags



5
pens

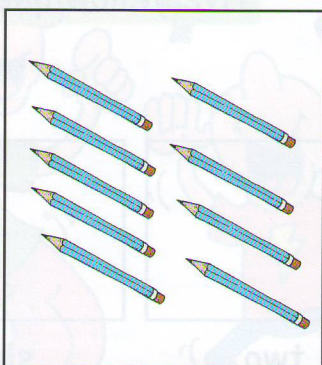

6
pencils

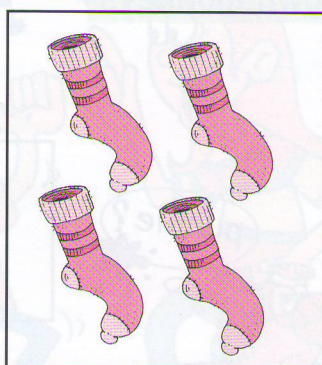

7
socks

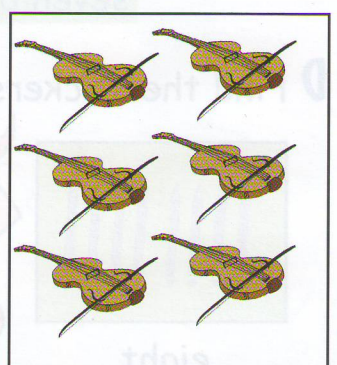

8
violins

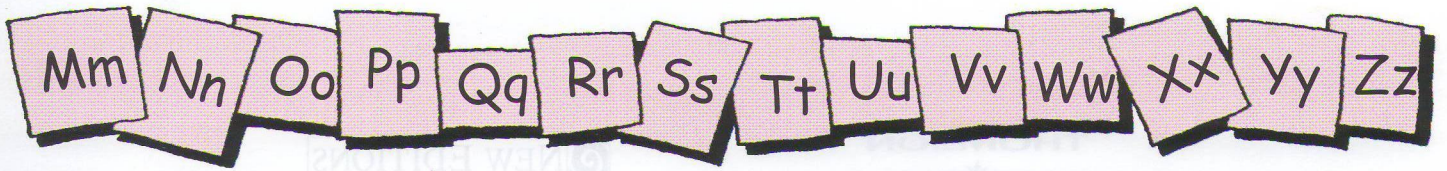

G Circle and write.

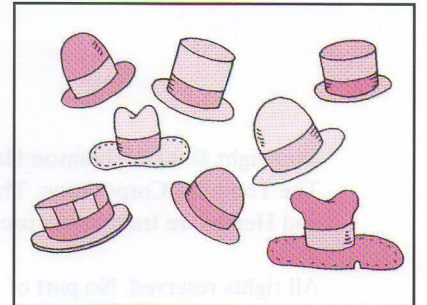
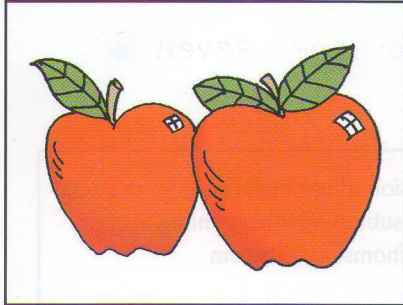

two three ten

four seven six

six one eight

blue red green

grey white brown

pink purple yellow

oranges bananas apples

cows bears gorillas

socks hats jumpers

two red apples

H Colour the picture.

Colour b blue.	blue	box
Colour g green.	green	bee
Colour o orange.	orange	yellow
Colour p purple.	purple	bird
Colour w brown.	brown	book
Colour y yellow.	yellow	worm